



CATÁLOGO DE RUEDAS





CONTENIDO

- RUEDAS CANAL EN V
- RUEDAS CANAL EN V CON SOPORTE
- RUEDAS CANAL CUADRADO
- RUEDAS CANAL REDONDO
- RUEDAS DOBLE RULEMÁN
- RODILLOS ESTABILIZADORES
- ESTABILIZADORES EN U Y EN L
- ESTABILIZADORES EN U Y EN L CON RODILLOS
- CIERRAPUERTAS
- PERFILES

RUEDAS V

CANAL EN V

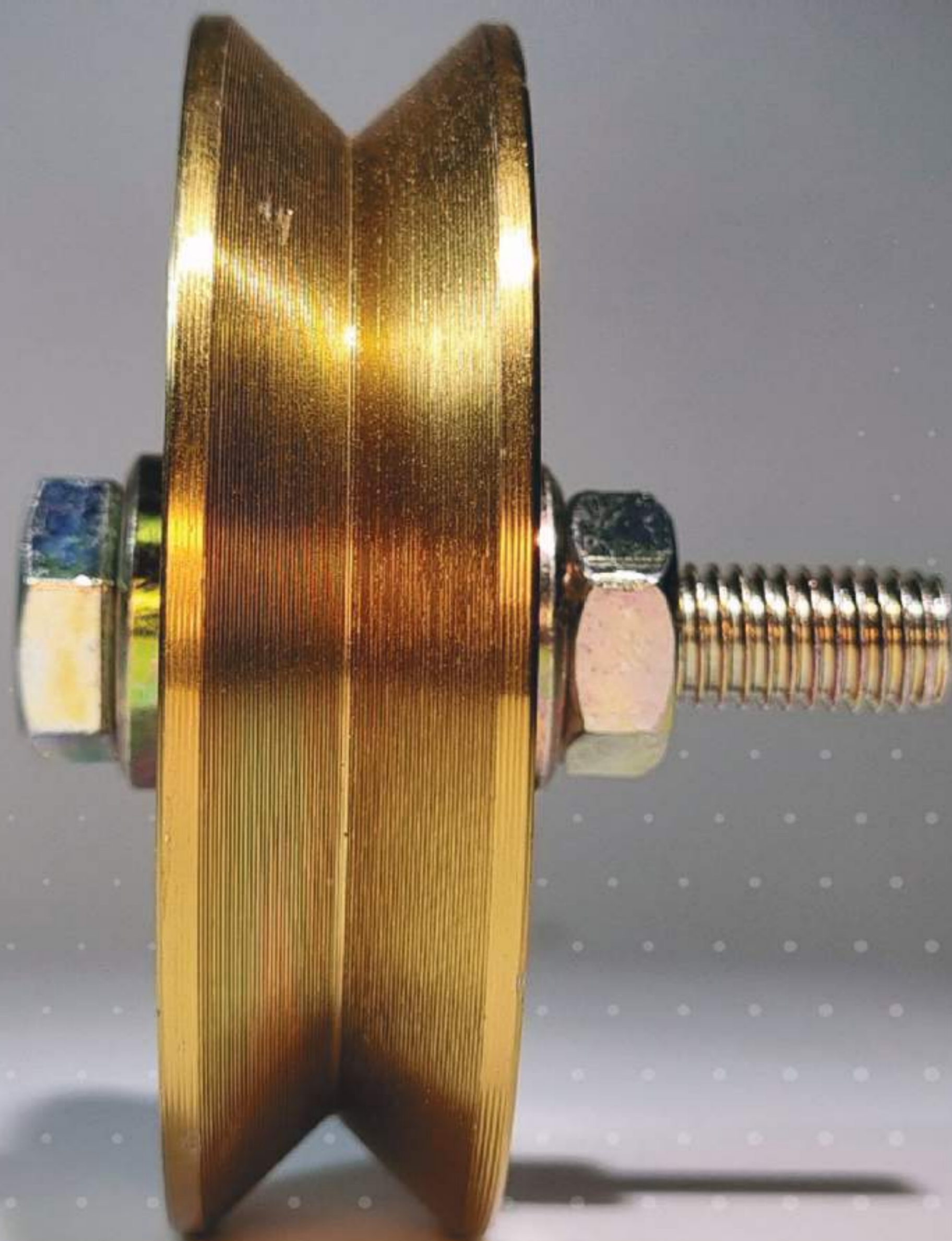



H-CV50



DIÁMETRO

48 mm



ANCHO DE RUEDA

17 mm



ANCHO DE RUEDA CON BUJE

22 mm



CAPACIDAD DOS RUEDAS

120 kg



RODAMIENTO

6201



MEDIDA DEL BULÓN

8x44



H-CV60



DIÁMETRO

58 mm



ANCHO DE RUEDA

17 mm



ANCHO DE RUEDA CON BUJE

22 mm



CAPACIDAD DOS RUEDAS

200 kg



RODAMIENTO

6202



MEDIDA DEL BULÓN

10x50



H-CV80



DIÁMETRO

78 mm



ANCHO DE RUEDA

20 mm



ANCHO DE RUEDA CON BUJE

28 mm



MÁX

CAPACIDAD DOS RUEDAS

200 kg



RODAMIENTO

6202



MEDIDA DEL BULÓN

10x60



H-CV90



DIÁMETRO

88 mm



ANCHO DE RUEDA

20.5 mm



ANCHO DE RUEDA CON BUJE

33 mm



CAPACIDAD DOS RUEDAS

300 kg



RODAMIENTO

6203



MEDIDA DEL BULÓN

12x60



H-CV100

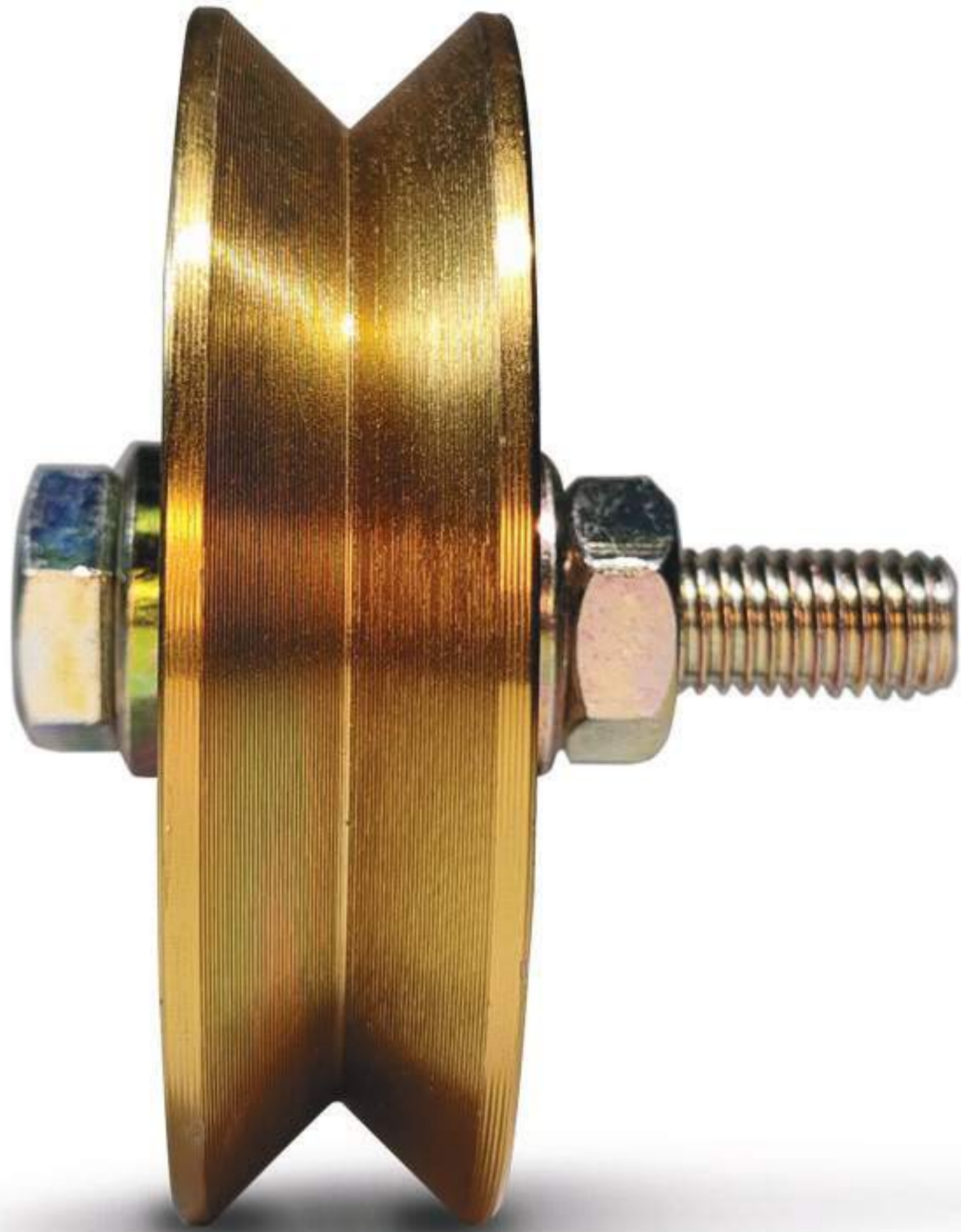

DIÁMETRO

98 mm



ANCHO DE RUEDA

22 mm



ANCHO DE RUEDA CON BUJE

33 mm



CAPACIDAD DOS RUEDAS

400 kg



RODAMIENTO

6203



MEDIDA DEL BULÓN

12x60



H-CV120

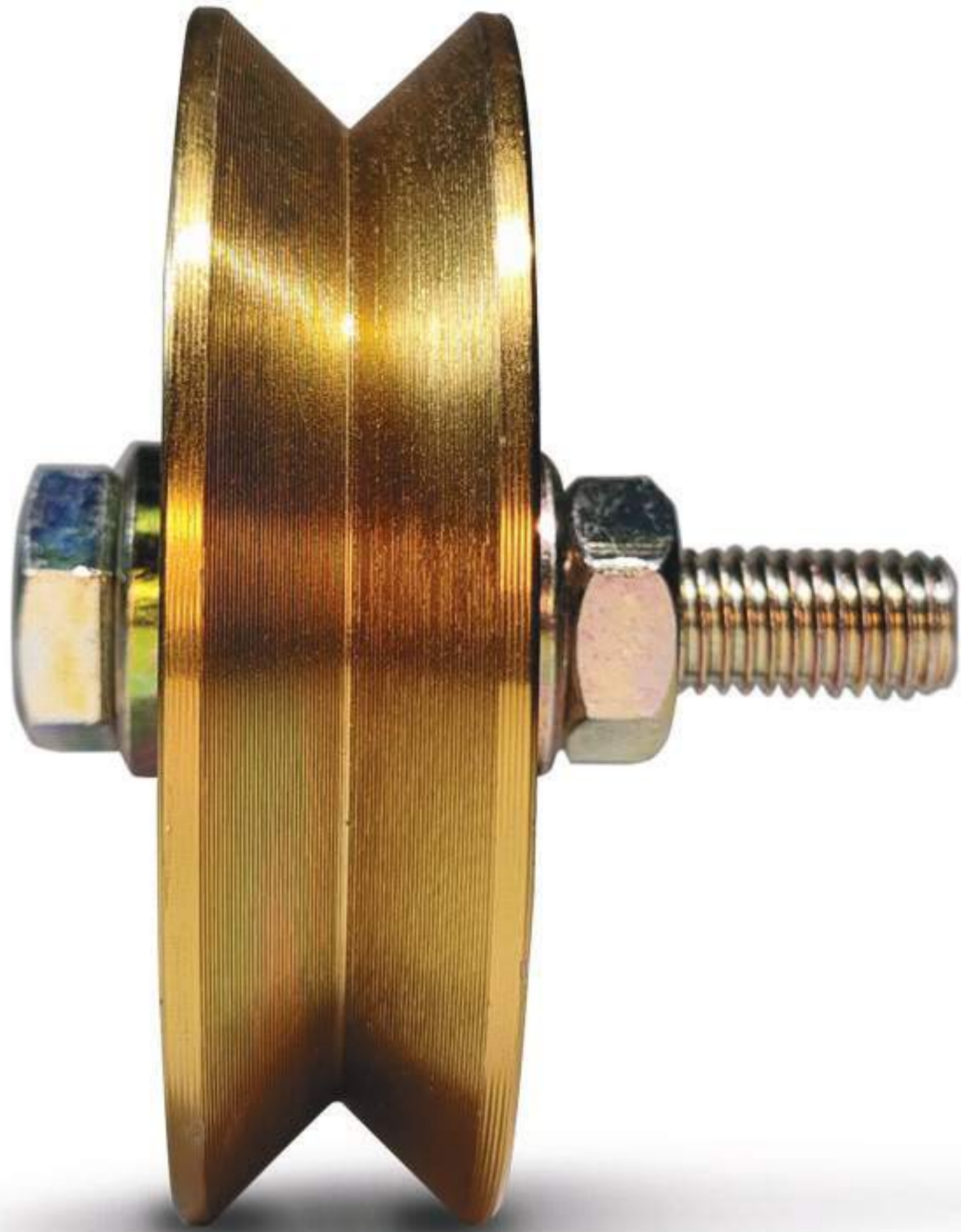

DIÁMETRO

118 mm



ANCHO DE RUEDA

25 mm



ANCHO DE RUEDA CON BUJE

44 mm



CAPACIDAD DOS RUEDAS

400 kg



RODAMIENTO

6203



MEDIDA DEL BULÓN

14x60



H-CV160



DIÁMETRO

158 mm



ANCHO DE RUEDA

30 mm



ANCHO DE RUEDA CON BUJE

44 mm



MÁX

CAPACIDAD DOS RUEDAS

700 kg



RODAMIENTO

6205



MEDIDA DEL BULÓN

16x70

RUEDAS V

CANAL EN

CON SOPORTE

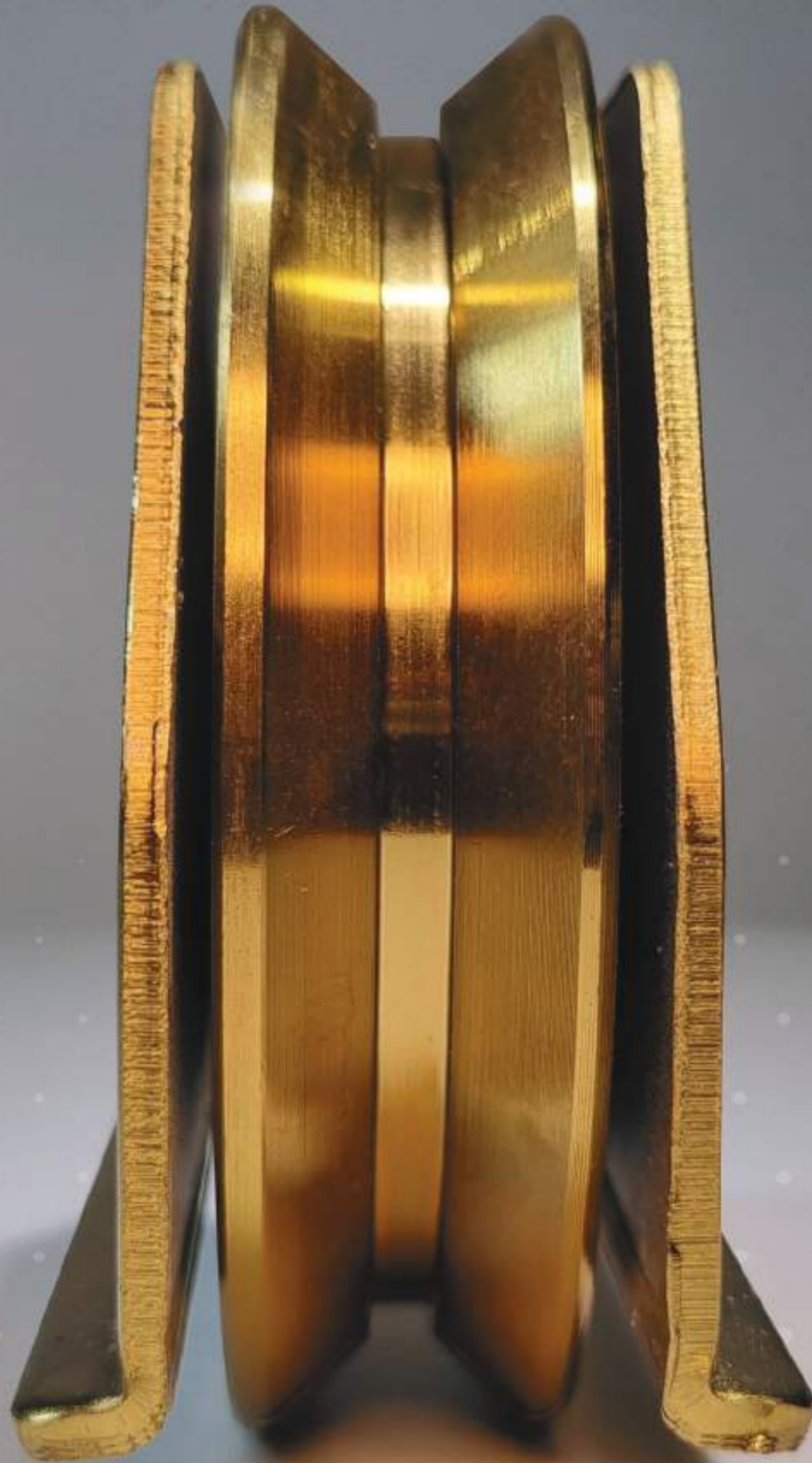



H-DY50



DIÁMETRO

48 mm



ANCHO DE RUEDA

15 mm



ANCHO DE RUEDA CON SOPORTE

25 mm



CAPACIDAD DOS RUEDAS

120 kg



H-DY60

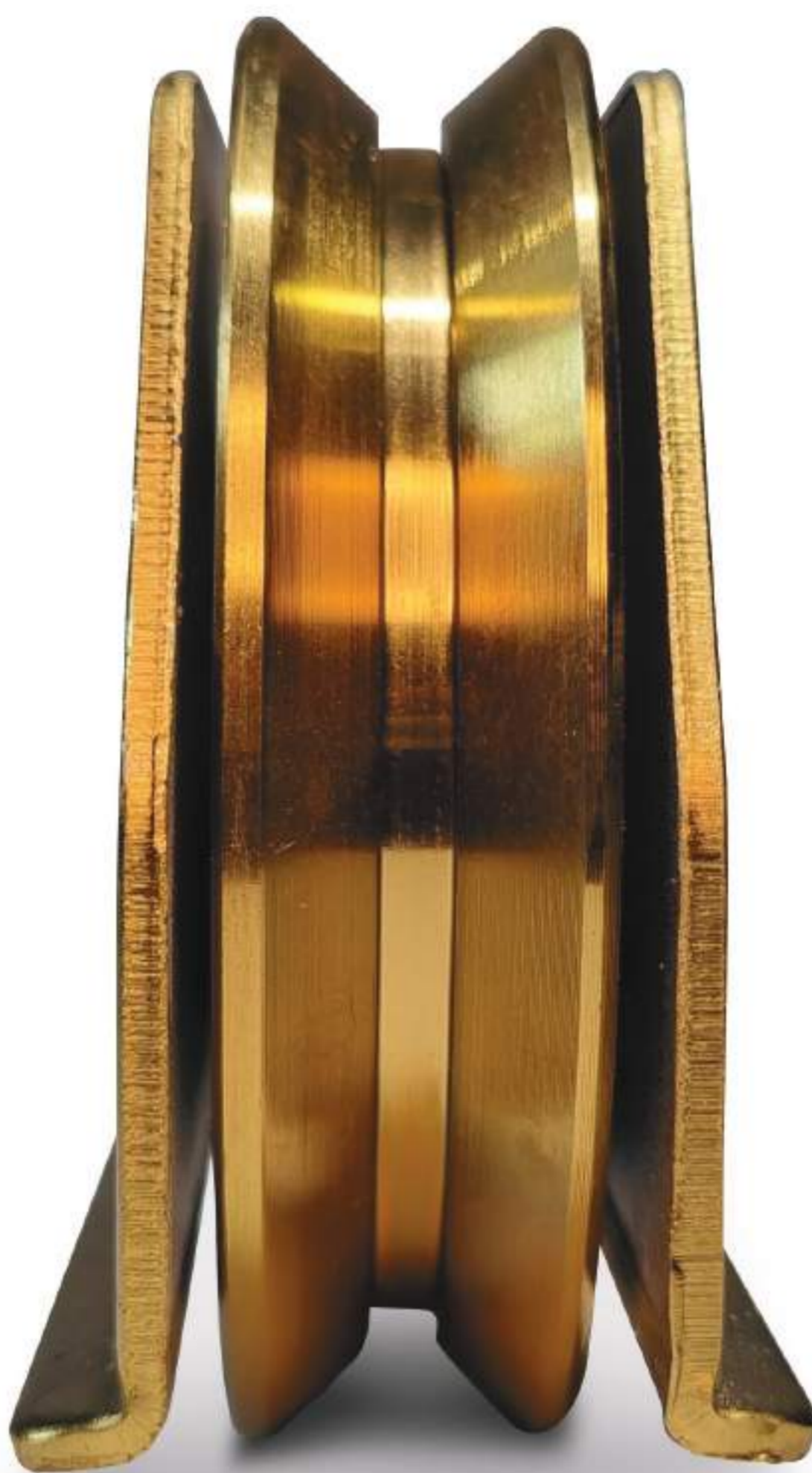

DIÁMETRO

58 mm



ANCHO DE RUEDA

17 mm



ANCHO DE RUEDA CON SOPORTE

28 mm



CAPACIDAD DOS RUEDAS

250 kg



H-DY80



DIÁMETRO

78 mm



ANCHO DE RUEDA

20 mm



ANCHO DE RUEDA CON SOPORTE

28 mm



CAPACIDAD DOS RUEDAS

300 kg



H-DY90



DIÁMETRO

88 mm



ANCHO DE RUEDA

20.7 mm



ANCHO DE RUEDA CON SOPORTE

30 mm



CAPACIDAD DOS RUEDAS

400 kg



H-DY90



DIÁMETRO

98 mm



ANCHO DE RUEDA

22 mm



ANCHO DE RUEDA CON SOPORTE

30 mm



CAPACIDAD DOS RUEDAS

500 kg



H-DY-CH 80



DIÁMETRO

78 mm



ANCHO DE RUEDA

22 mm



ANCHO DE RUEDA CON SOPORTE

28 mm



CAPACIDAD DOS RUEDAS

300 kg

RUEDAS

CANAL CUADRADO

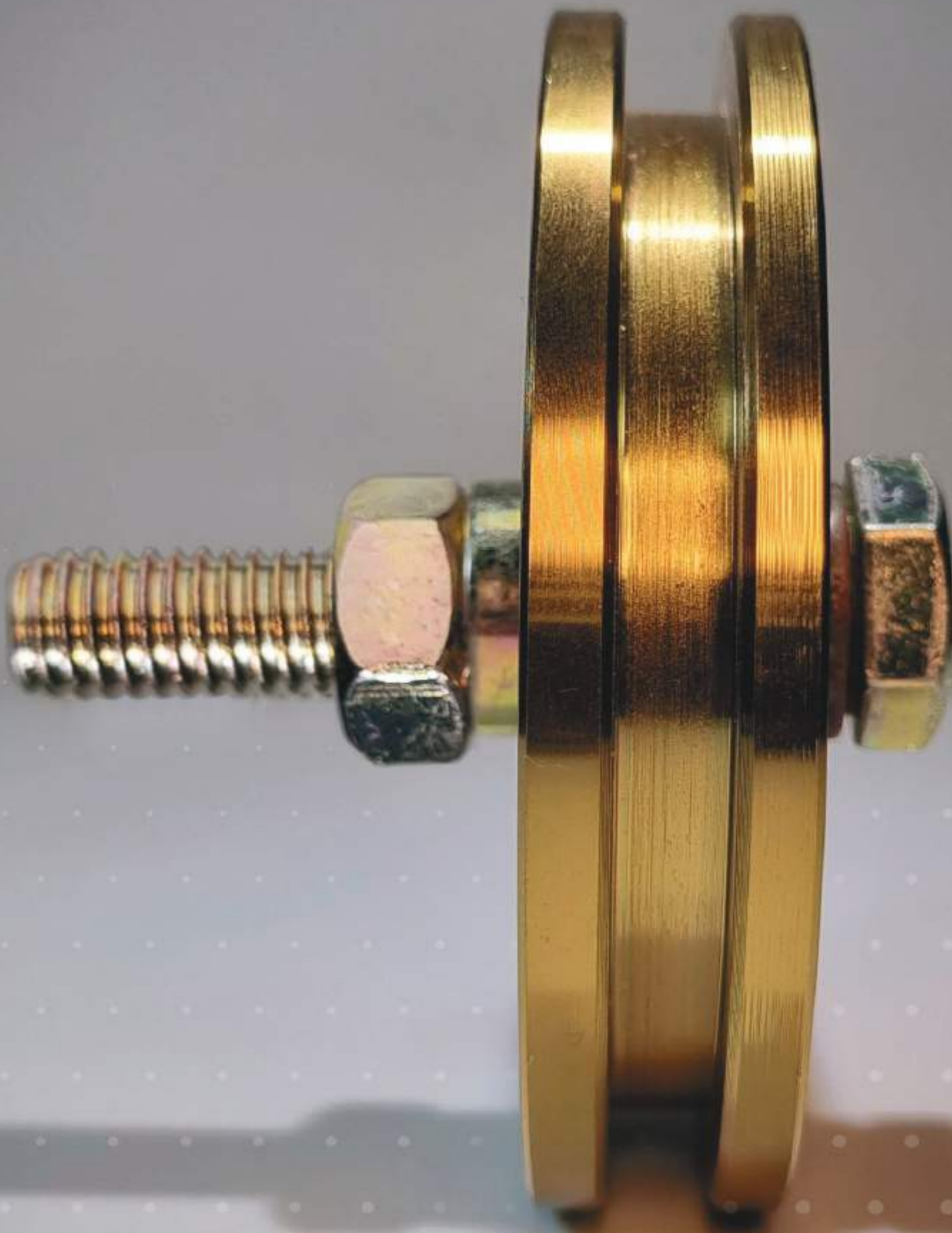



H-CH 50

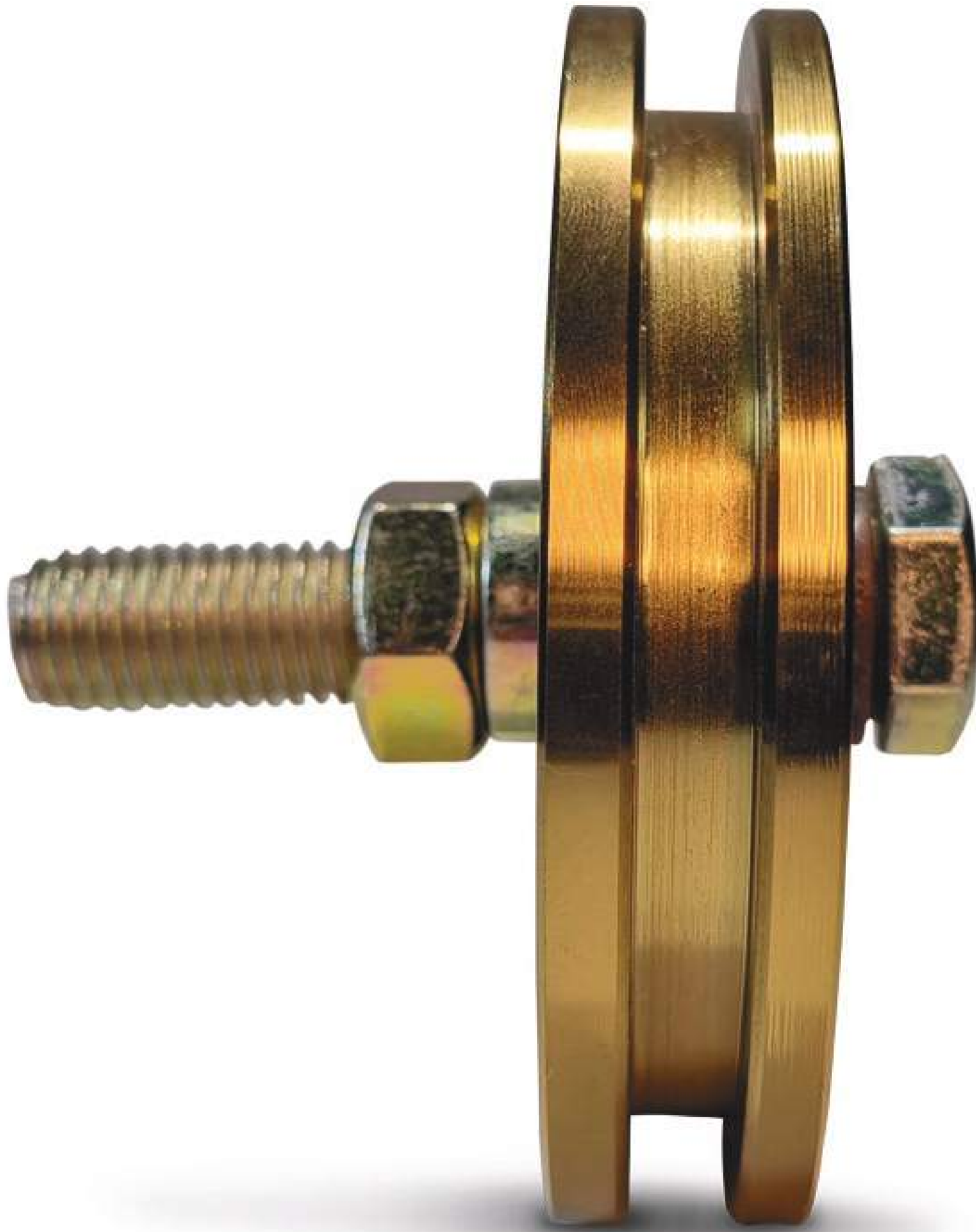

DIÁMETRO

48 mm



ANCHO DE RUEDA CON BUJE

22 mm



ANCHO Y PROFUNDIDAD DEL CANAL

5,9x5,30 mm



CAPACIDAD DOS RUEDAS

120 kg



RODAMIENTO

6002



MEDIDA DEL BULÓN

8x45



H-CH 60

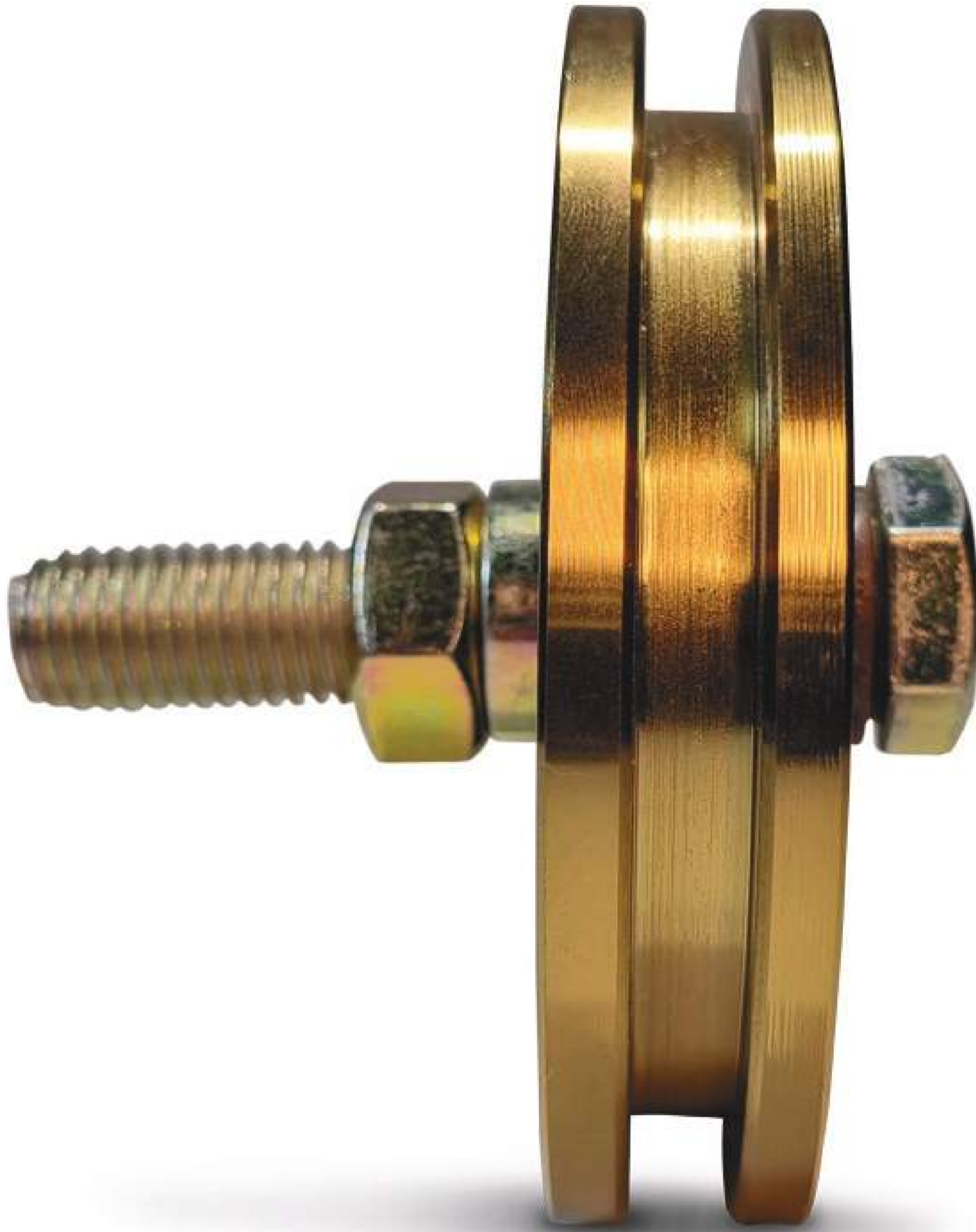

DIÁMETRO

58 mm



ANCHO DE RUEDA CON BUJE

22 mm



ANCHO Y PROFUNDIDAD DEL CANAL

6,9x6,30 mm



MÁX

CAPACIDAD DOS RUEDAS

200 kg



RODAMIENTO

6002



MEDIDA DEL BULÓN

10x45



H-CH 80

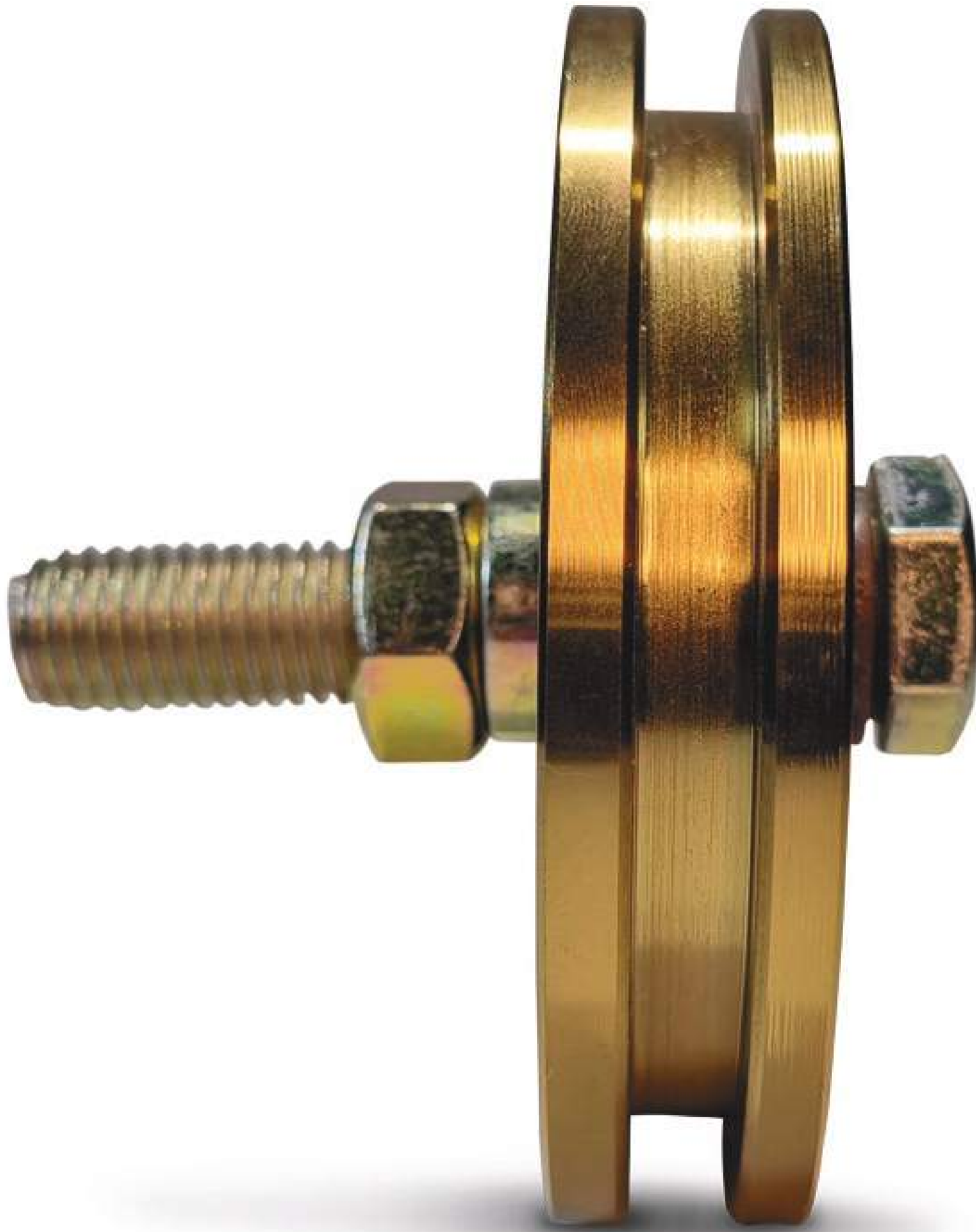

DIÁMETRO

78 mm



ANCHO DE RUEDA CON BUJE

27 mm



ANCHO Y PROFUNDIDAD DEL CANAL

7,8x8,20 mm



MÁX

CAPACIDAD DOS RUEDAS

300 kg



RODAMIENTO

6002



MEDIDA DEL BULÓN

10x60



H-CH 90

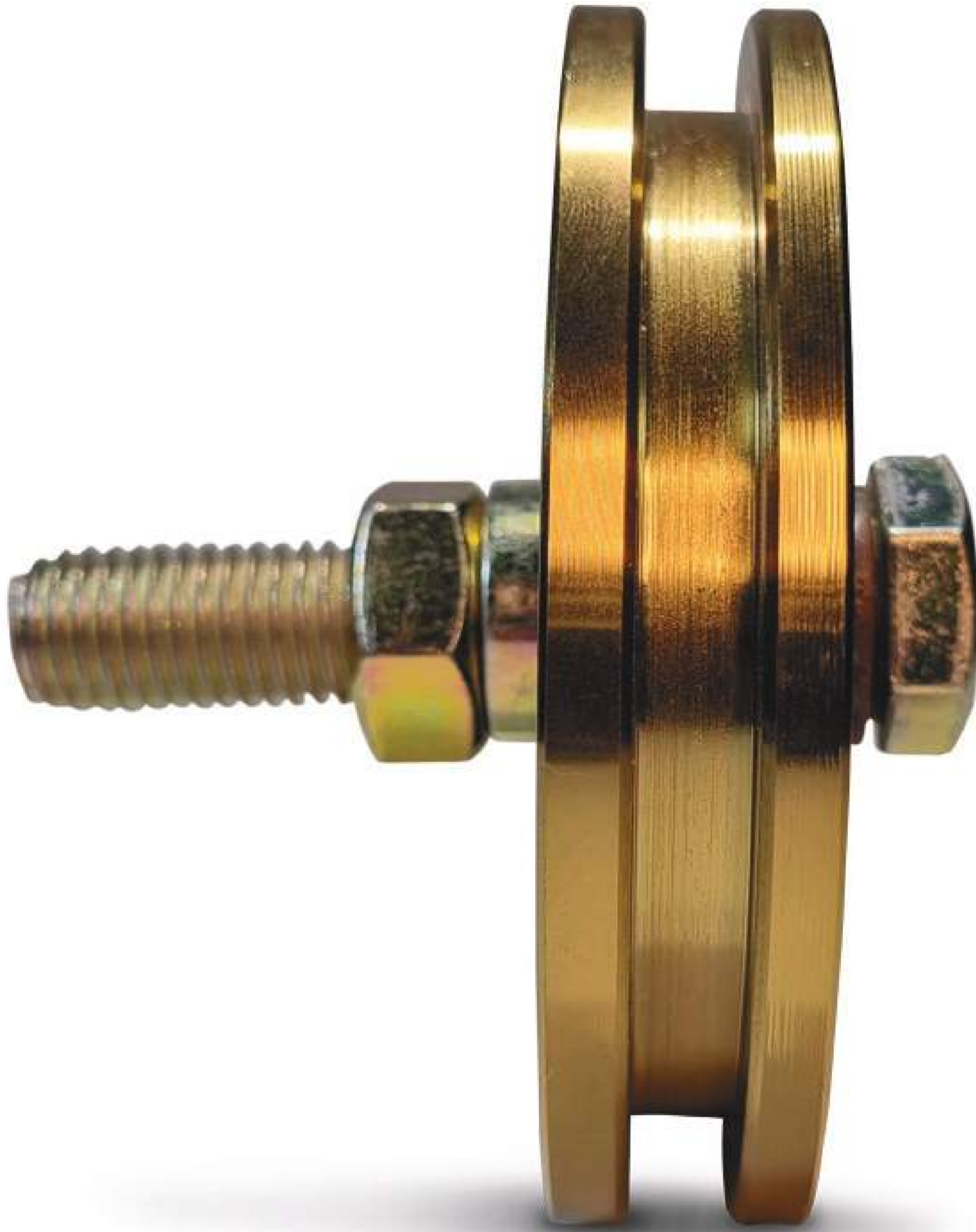

DIÁMETRO

88 mm



ANCHO DE RUEDA CON BUJE

30 mm



ANCHO Y PROFUNDIDAD DEL CANAL

8x7,50 mm



MÁX

CAPACIDAD DOS RUEDAS

300 kg



RODAMIENTO

6003



MEDIDA DEL BULÓN

12x60



H-CH 100

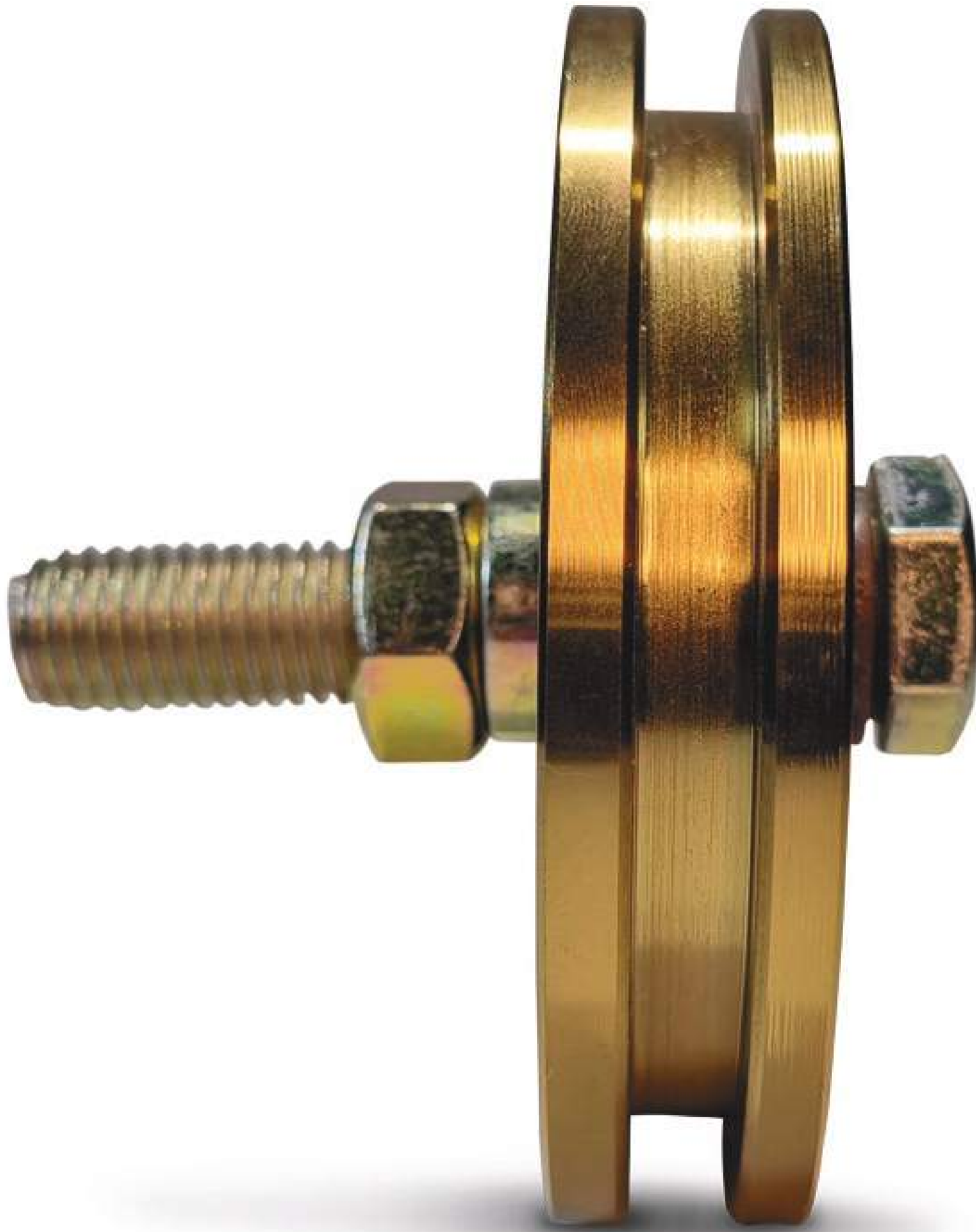

DIÁMETRO

98 mm



ANCHO DE RUEDA CON BUJE

30 mm



ANCHO Y PROFUNDIDAD DEL CANAL

8x8 mm



MÁX

CAPACIDAD DOS RUEDAS

400 kg



RODAMIENTO

6003



MEDIDA DEL BULÓN

14x60



H-CH 120

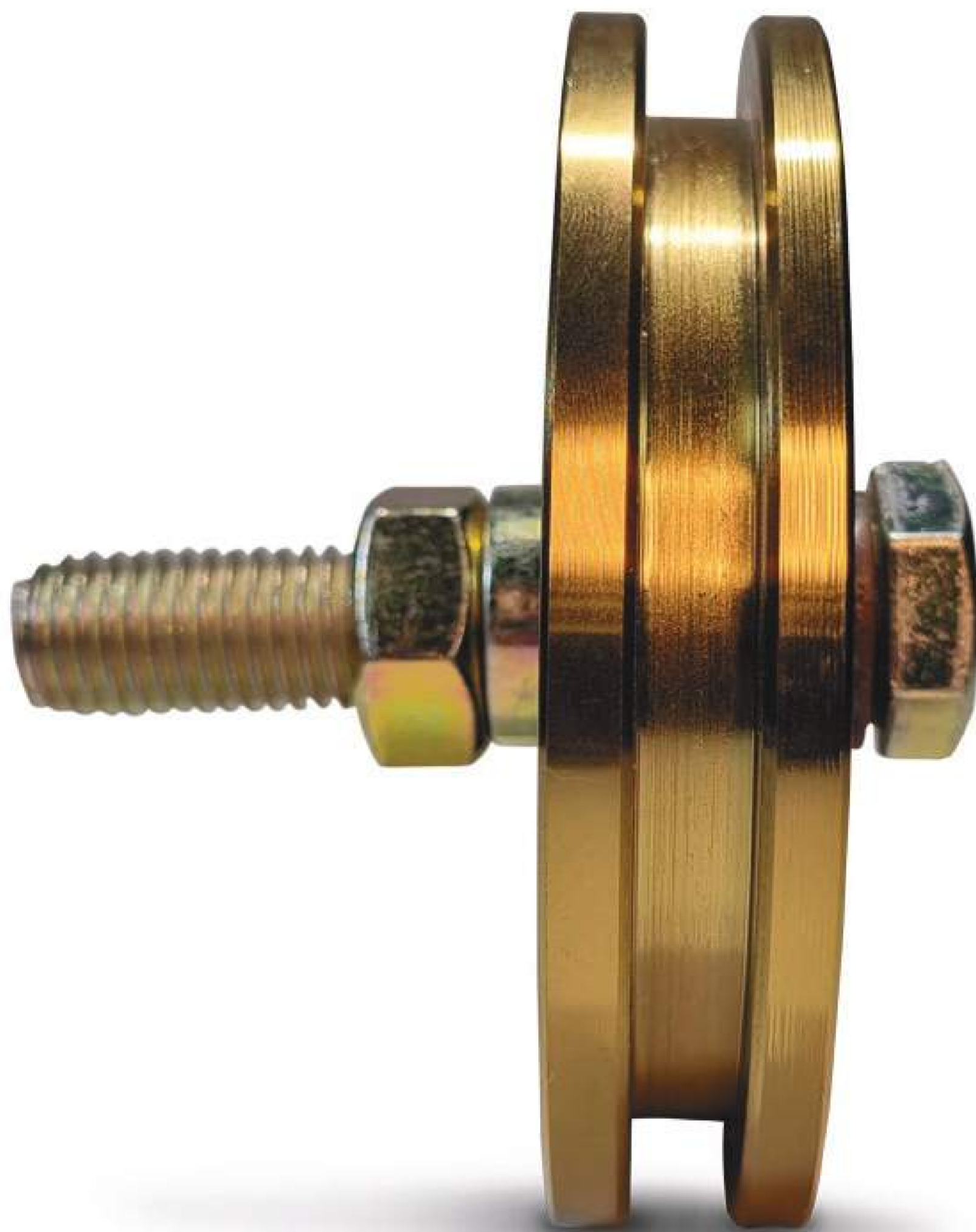

DIÁMETRO

118 mm



ANCHO DE RUEDA CON BUJE

35 mm



ANCHO Y PROFUNDIDAD DEL CANAL

15,8x10 mm



MÁX

CAPACIDAD DOS RUEDAS

400 kg



RODAMIENTO

6003



MEDIDA DEL BULÓN

16x60

RUEDAS

CANAL REDONDO

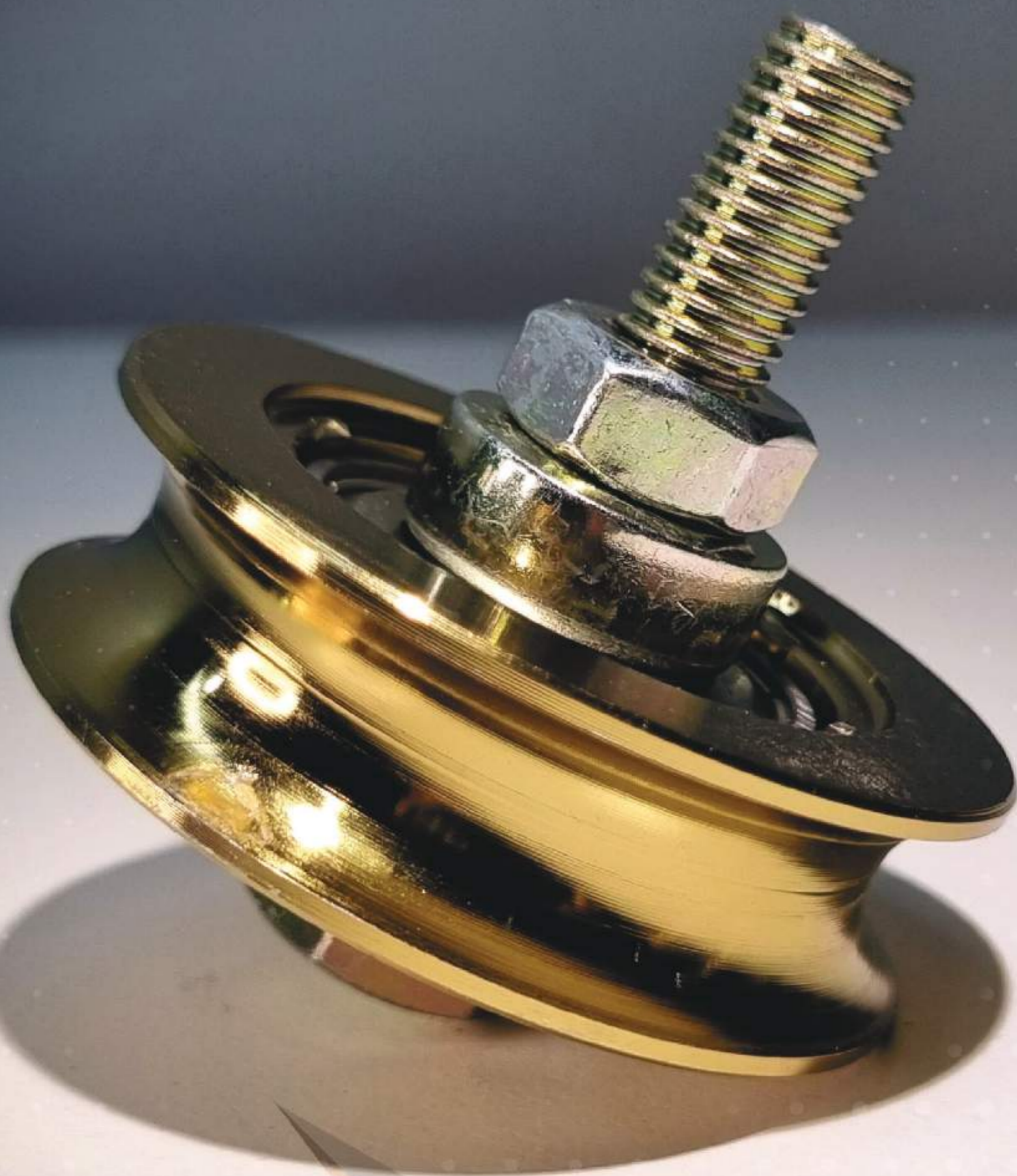



HCU-60



DIÁMETRO

58 mm



ANCHO DE RUEDA

14,5 mm



DIÁMETRO DEL CANAL

12 mm



MÁX

CAPACIDAD DOS RUEDAS

300 kg



RODAMIENTO

6002



MEDIDA DEL BULÓN

10x50



HCU-80



DIÁMETRO

78 mm



ANCHO DE RUEDA

20 mm



DIÁMETRO DEL CANAL

14 mm



CAPACIDAD DOS RUEDAS

400 kg



RODAMIENTO

6002



MEDIDA DEL BULÓN

12x60

RUEDAS

DOBLE RULEMAN



HDB-CV80

DOBLE RULEMAN



DIÁMETRO

78 mm



ANCHO DE RUEDA

23 mm



ANCHO DE RUEDA CON BUJE

44 mm



CAPACIDAD DOS RUEDAS

350 kg



RODAMIENTO

6202



MEDIDA DEL BULÓN

12x60

RODILLOS

ESTABILIZADORES

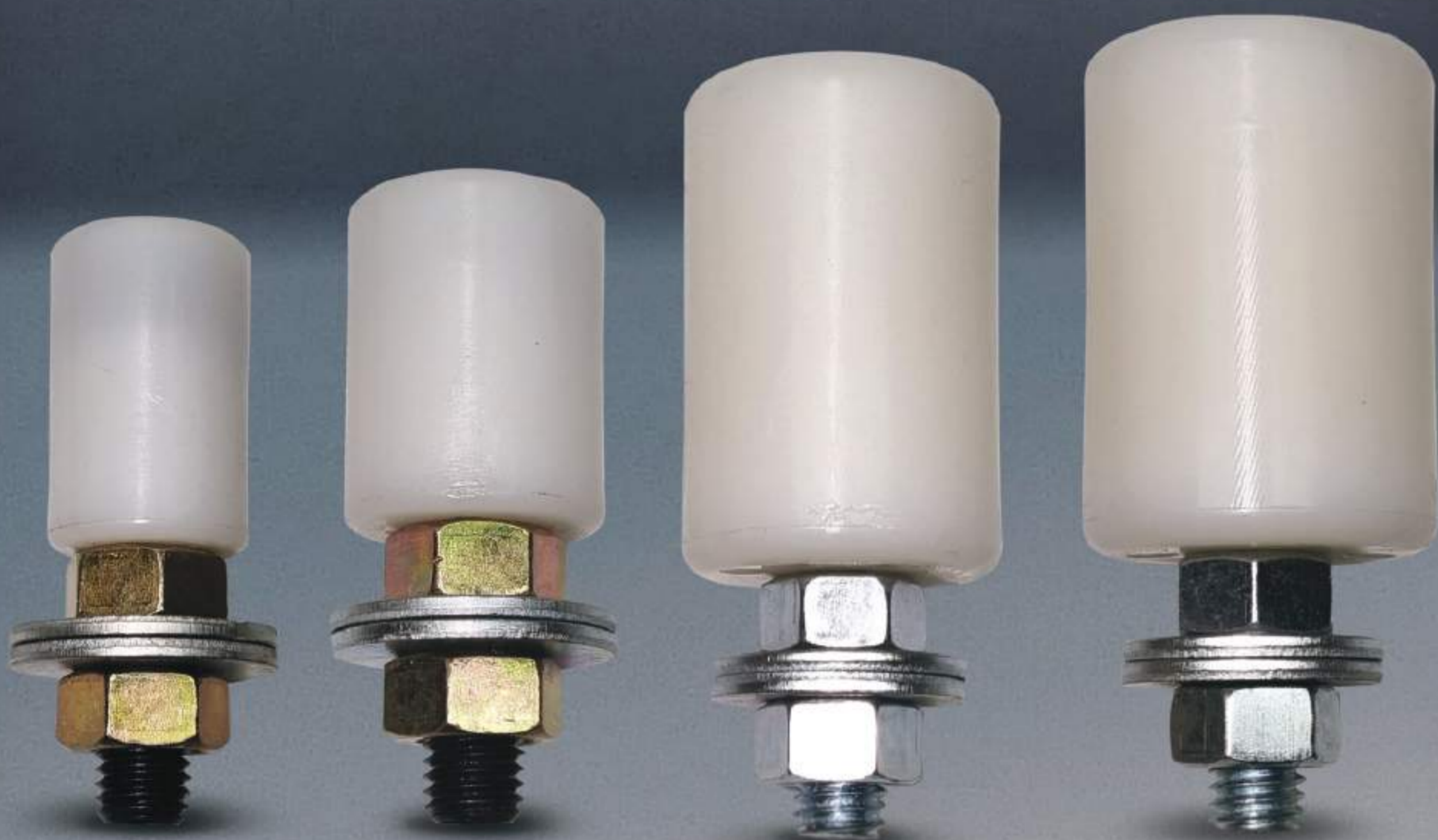



NR2540



DIÁMETRO

25,5 mm



LARGO

40 mm



LARGO CON BULÓN

70 mm



TIPO DE BULÓN

TORNILLO ALLEN M12X1,75X60



NR3140



DIÁMETRO

31 mm



LARGO

40 mm



LARGO CON BULÓN

74 mm



TIPO DE BULÓN

TORNILLO ALLEN M12X1,75X60



NR41404



DIÁMETRO

38 mm



LARGO

60 mm



LARGO CON BULÓN

100 mm



TIPO DE BULÓN

TORNILLO HEXAGONAL 7/16"X3



NR4160



DIÁMETRO

41 mm



LARGO

43 mm



LARGO CON BULÓN

90 mm



TIPO DE BULÓN

TORNILLO HEXAGONAL 7/16"X3

ESTABILIZADORES

EN **U** / EN **L**

CON RODILLOS

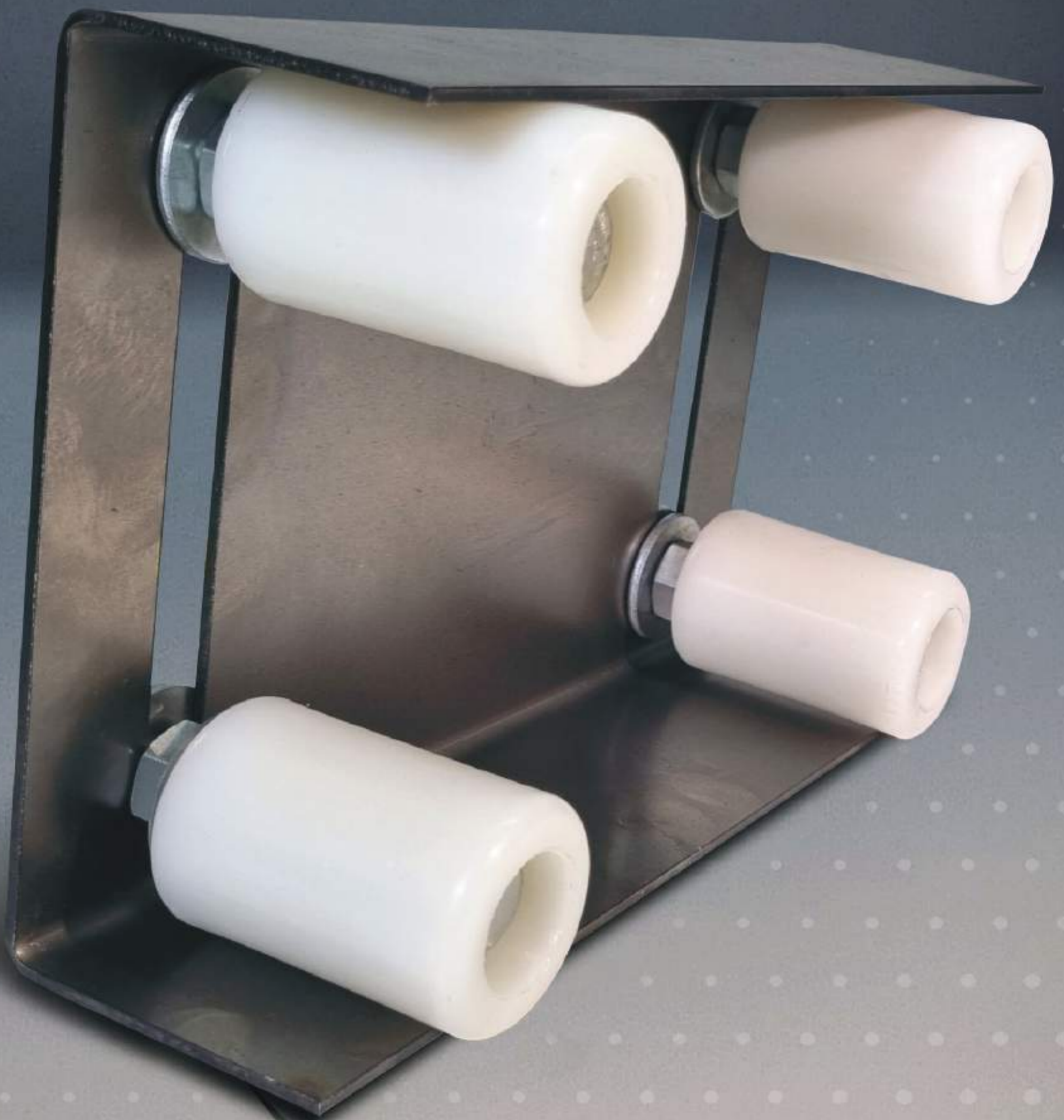



ESTABILIZADORES EN U CON RODILLOS

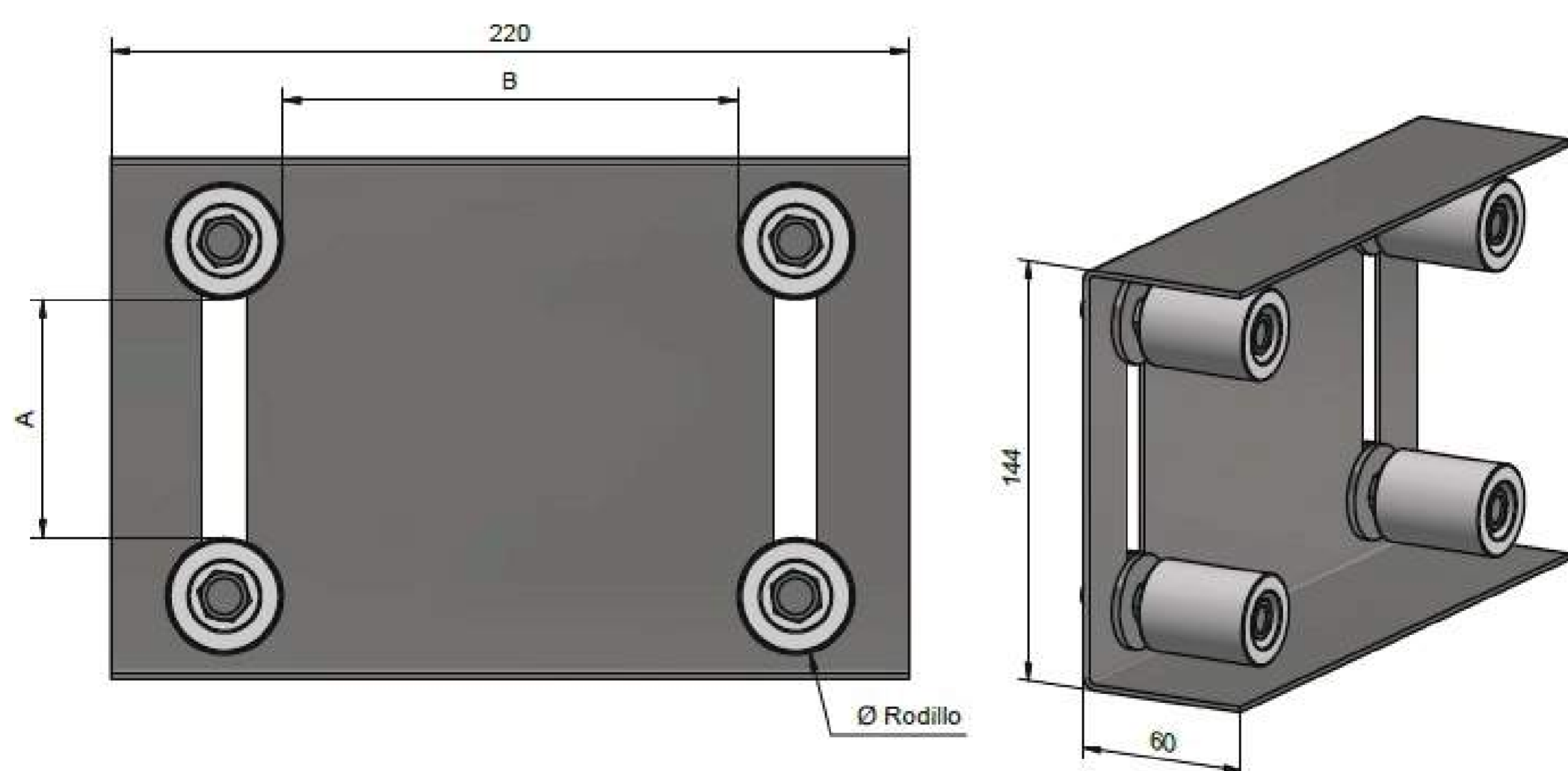

Ø Rodillo (mm)	Amax (mm)	B (mm)	Tornillo	Ranura Ancho x largo (mm)	Espesor de chapa (mm)
25	73	132	Allen Cab. Cil.12X1,75X60	12.2x110	2.2
31	67	126	Allen Cab. Cil.12X1,75X60		
38	60	119	Cab. Hex 7/16"x3"		
41	57	116	Cab. Hex 7/16"x3"		



ESTABILIZADORES EN L CON RODILLOS

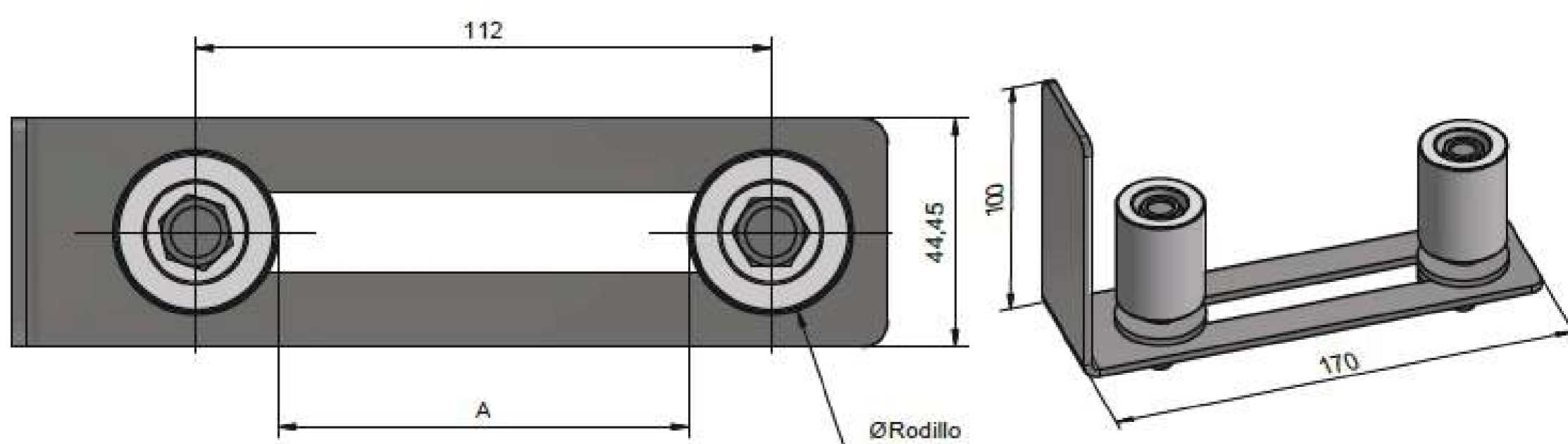

Ø Rodillo (mm)	Amax (mm)	Tornillo	Ranura Ancho x largo (mm)	Espesor de chapa (mm)
25	87	Allen Cab. Cil.12X1,75X60	15.4x127	3
31	81	Allen Cab. Cil.12X1,75X60		
38	73	Cab. Hex 7/16"x3"		
41	71	Cab. Hex 7/16"x3"		

CIERRA- PUERTAS





M1102D



PESO MÍNIMO

25 kg



PESO MÁXIMO

45 kg



M1102D



PESO MÍNIMO

60 kg



PESO MÁXIMO

85 kg



COLORES



BLANCO ▶

GRIS PLATA ▶

DORADO ▶



COLORES

VERDE ▶

AZUL ▶

NEGRO ▶

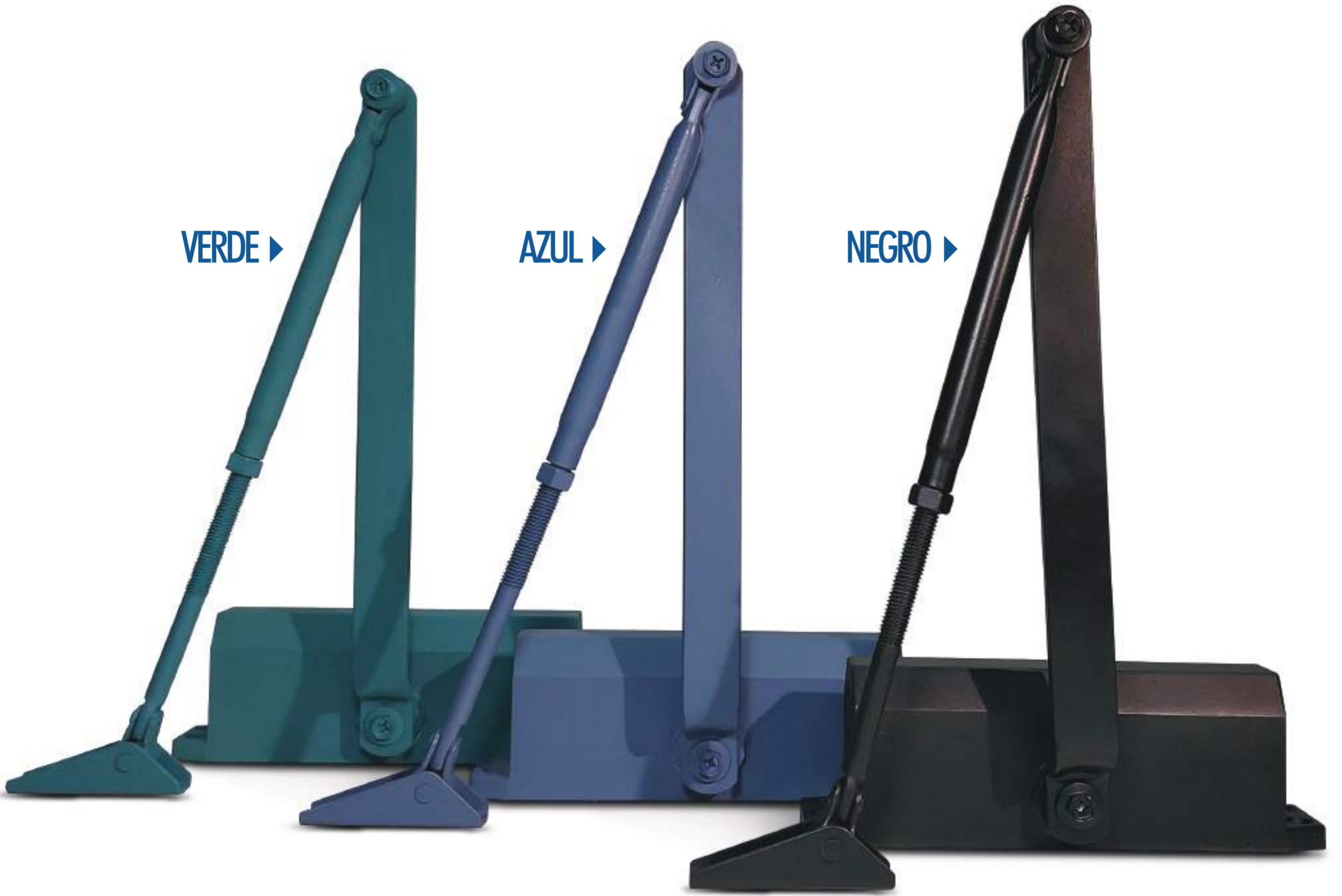



COLORES

GRIS ▶

COBRE ▶

MARRÓN ▶



PERFILES
RIEL GUÍA
PARA CARRRO





HRG25-300



ANCHO

33 mm



ALTO

37 mm



LARGO

3 m



ANCHO DE RANURA

6,7 mm



HRG38-300



ANCHO

48 mm



ALTO

51 mm



LARGO

3 m



ANCHO DE RANURA

15 mm

info@bbsmotion.com.ar
(02320) 302 330



COLECTORA OESTE 1658 / DEL VISO / CP: 1669



SEGUINOS EN REDES

